

ENFORCER®

Outdoor Piezoelectric Request-to-Exit Pushbuttons

Manual



SD-6176-SSQ	Slimline plate, "TOUCH/EXIT"
SD-6176-SS1Q	Slimline plate, "EXIT/SALIDA"
SD-6176-SSVQ	Slimline plate, manual override
SD-6276-SSQ	Single-gang plate, "TOUCH/EXIT"
SD-6276-SS1Q	Single-gang plate, "EXIT/SALIDA"
SD-6276-SSVQ	Single-gang plate, manual override

- Piezoelectric push buttons for indoor or outdoor use (IP65).
- LED ring around button changes from green to red or red to green when the button is pressed.
- Timed or toggle output.
- Includes separate manual override button in case power to piezoelectric push button fails.
- Relay rated 2A@30VDC with two individually programmable outputs (NO/NC).

Specifications:

Operating voltage		12~24 VDC
Current drain		100mA@12VDC
Contact rating		2A@30VDC or 0.5A@125VAC
Ring LED Colors reversible via switch	Standby	Red
	Active	Green
Output time		1~30 s, Toggle
IP rating		IP65
Operating temperature		32°~158° F (0°~70° C)
Plate material		Stainless steel
Weight	Single-Gang	3.5-oz (99g)
	Single-Gang w/Manual Override	4-oz (113g)
	Slimline	2.6-oz (74g)
	Slimline w/Manual Override	3.1-oz (88g)

Parts List:

Piezoelectric push button.....	1 x	Mounting screws.....	2 x
Wires for manual override ¹	2 x	Manual.....	1 x

Overview:

SD-6176-SSVQ and SD-6276-SSVQ with Manual Override button shown, other models similar.

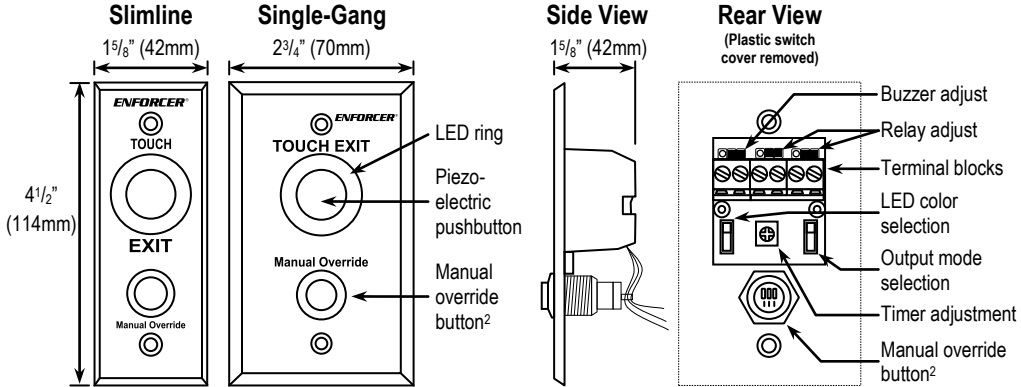

Installation:

1. Prepare wiring to provide 12~24 VDC power and connect devices to the relay outputs.
- Note:** The device includes one relay with two outputs. Outputs trigger simultaneously but can be configured independently. To set the output modes, see Relay Output Modes on page 3.
2. Remove the plastic cover from the rear of the switch and carefully pierce the rubber grommet.
3. **SD-6176-SSVQ and SD-6276-SSVQ:** Wire the manual override button. See page 3.
4. Wire the switch according to the diagram on the right.
 - Connect (-) and (+) to a 12~24 VDC power source.
 - Connect other devices to Outputs 1 or 2.
5. Replace the plastic switch cover and screw the plate onto the mounting surface.

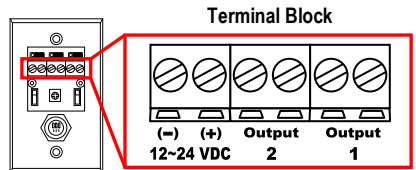

¹ SD-6176-SSVQ and SD-6276-SSVQ only.

Wiring the Manual Override:

SD-6176-SSVQ and SD-6276-SSVQ Only

Connect the manual override button with the included wires.

Wiring For N.O.:

Connect the two wires between the NO and COM terminals of the override button and the Output 1 or 2 terminals on the switch.

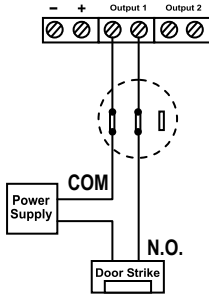

Wiring For N.C.:

Connect the two wires between the NC and COM terminals of the override button and the Output 1 or 2 terminals on the switch.

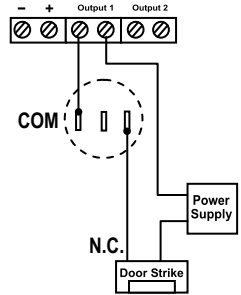

Notes

- Remove the thin panel on the bottom of the plastic cover to allow wiring to pass through.
- There is only one relay, wiring the button to either output will allow the other output to trigger simultaneously.
- Do not connect the manual override button to more than one output.
- When wiring for either N.O. or N.C., be sure to also set the Relay Output Mode to N.O., as described below.
If Relay Output Mode and override button wiring do not match, the product may not function as expected.

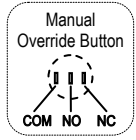

Configuring the Pushbutton:

1. Buzzer Output

DEFAULT: ON

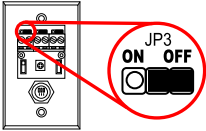

Use the buzzer output jumper JP3 to program the buzzer output. Placing the jumper on the left turns buzzer output ON. Placing the jumper on the right turns buzzer output OFF.

2. Relay Output Mode

DEFAULT: N.O.

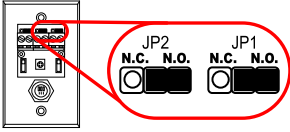

Outputs 1 and 2 can be set independently using jumpers JP1 and JP2. Note: Both outputs trigger simultaneously. Place the jumper on the right for N.O. operation and on the left for N.C. operation.

3. LED Ring Colors

DEFAULT: OFF

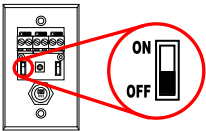

ON: LED is green while in standby, and turns red when triggered.
OFF: LED is red while in standby, and turns green when triggered.

4. Switch Output Type

DEFAULT: Timer

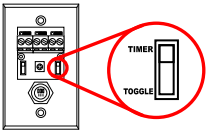

TIMER: When set to TIMER, pressing the switch will trigger the relay for the set time. Set the time using the trimpot as described above.
TOGGLE: When set to TOGGLE, pressing the switch will cause the relay to trigger until the switch is pressed again.

5. Timer Adjustment

DEFAULT: 1s

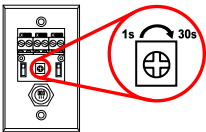

Output duration is adjustable 1~30 seconds. (Must be set to 'Timer' in step 4)
Gently rotate the trimpot using a Philips head screwdriver.
Counterclockwise decreases the output time.
Clockwise increases the output time.

Sample Installation: Electromagnetic Lock (Fail-Safe) with Strobe Light

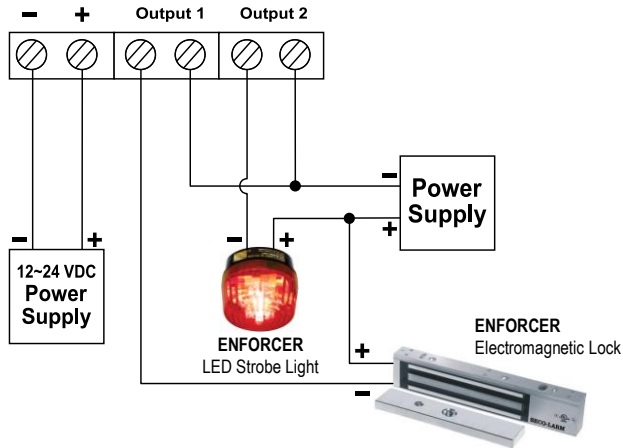

Also Available from SECO-LARM:

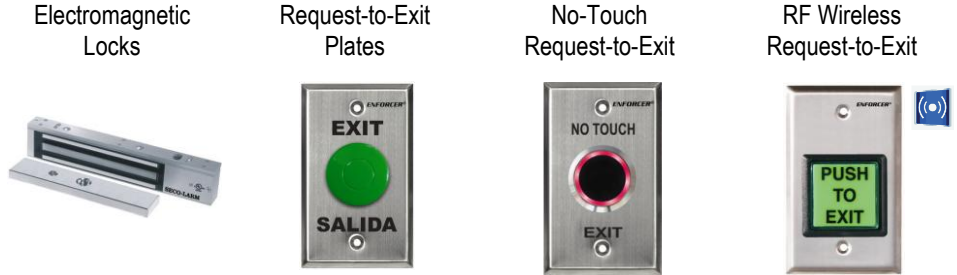

WARRANTY This SECO-LARM product is warranted against defects in material and workmanship while used in normal service for a period of one (1) year from the date of sale to the original consumer customer. SECO-LARM's obligation is limited to the repair or replacement of any defective part if the unit is returned, transportation prepaid, to SECO-LARM. This Warranty is void if damage is caused by or attributed to acts of God, physical or electrical misuse or abuse, neglect, repair, or alteration, improper or abnormal usage, or faulty installation, or if for any other reason SECO-LARM determines that such equipment is not operating properly as a result of causes other than defects in material and workmanship. The sole obligation of SECO-LARM, and the purchaser's exclusive remedy, shall be limited to replacement or repair only, at SECO-LARM's option. In no event shall SECO-LARM be liable for any special, collateral, incidental, or consequential personal or property damages of any kind to the purchaser or anyone else.

NOTICE: The information and specifications printed in this manual are current at the time of publication. However, the SECO-LARM policy is one of continual development and improvement. For this reason, SECO-LARM reserves the right to change specifications without notice. SECO-LARM is also not responsible for misprints or typographical errors.

Copyright © 2011 SECO-LARM U.S.A., Inc. All rights reserved. This material may not be reproduced or copied, in whole or in part, without the written permission of SECO-LARM.

SECO-LARM® U.S.A., Inc.

16842 Millikan Avenue, Irvine, CA 92606
Tel: 800-662-0800 / 949-261-2999 Fax: 949-261-7326

Website: www.seco-larm.com
E-mail: sales@seco-larm.com

 PIHWK1
MSD-6x73-SSxQ 1111.docx